

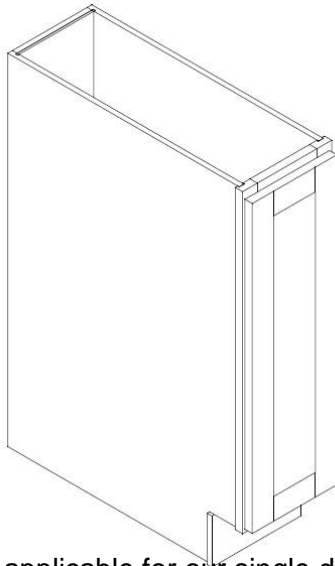

MALIBU WHITE ASSEMBLY INSTRUCTIONS



These assembly instructions are applicable for our single door base cabinet Only
ITEM NO.:BC09WH,BC12FHWH,BC15FHWH,BC18FHWH,BC21FHWH

► **General Instructions:**

Thank you for choosing a B. JORGSEN & CO. product. You are now the proud owner of a high quality product designed to face the test of daily use and guaranteeing your enjoyment for many years to come.

Carefully read the instructions before starting the installation.

During assembly, please follow all generally accepted safety procedures.

Failure to adhere to the following instructions will invalidate the warranty and B. JORGSEN & CO. will decline any responsibility for any damages caused. Any installation which does not correspond to the instructions may result in defects, malfunctioning parts, significant damage and/or injury.

Before the assembly begins, check that all appropriate and required plumbing and electrical connections exist.

Before drilling, make absolutely sure that there are no pipes (gas, water, electricity, heating, etc.) at the drilling location.

B. JORGSEN & CO. will not be held responsible for failure to follow these instructions.

**PRIOR TO ASSEMBLY, PLEASE MAKE SURE YOU HAVE ONE FACE FRAME BOX AND ONE CARCASS BOX, WHICH HAVE ALL THE PARTS IN THE QUANTITIES MENTIONED BELOW. IF YOU ARE MISSING ANY PART, PLEASE STOP AND CONTACT US IMMEDIATELY
ON: 1-800-CABINET OPTION 5**

The following is the list of all the items contained in this box:

► Items Quantity

Item	Description	Qty
A	Face Frame with Door	1
B	Side Panels	2
C	Bottom Panel	1
E	Back Panel	1
F	Shelf	1
G	Toe Kick	1
J	Hardware Box:	
	Plastic corner bracket(K) 4pcs, 1/2" round head screws 8pcs, Shelf clips 4 pcs, 1" screw 4pcs	

► Required tools:

- Screwdriver
- Adjustable wrench
- Measuring Tape
- Pencil
- Level
- Silicone

► Instructions:

1. Place the face frame (A) face down on a flat soft working surface to ensure that the face is not scratched or damaged (Figure 1).

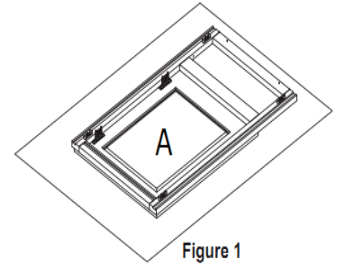

2. Installing the Side Panels (Figure 2): Insert right and left side panels (B) into the grooves of the face frame (A) and align the cam lock connectors (Figure 2). Lock the cam with a screwdriver by turning the screw 180° degrees clockwise (Figure 4).

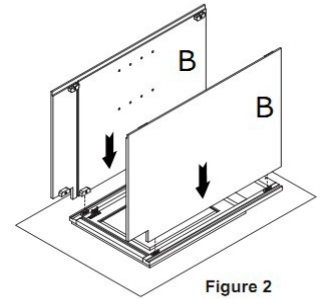

3. Installing the Bottom (Figure 3): Gently spread the side panels and insert the bottom (C) into the grooves of side panel (B) until it touches the face frame (A). Align it and lock each cam.

4. Installing the Back Panel and Toe Kick (Figure 5): Put the back panel(E) at rear of side panel(B)(Figure 5). Align and lock each cam lock. Install the Toe Kick(G) by locking the cam lock at both ends(Figure 5)

5. Installing the Shelves: Insert the shelf clips into the holes on the side panels at the desired height and slide in the shelves (F).

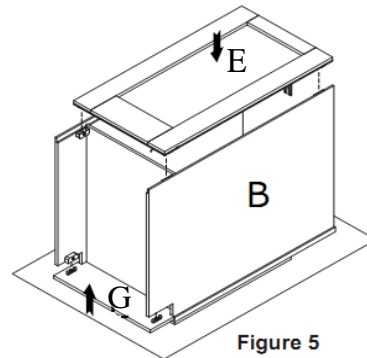
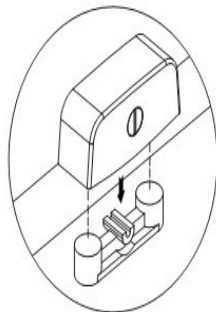
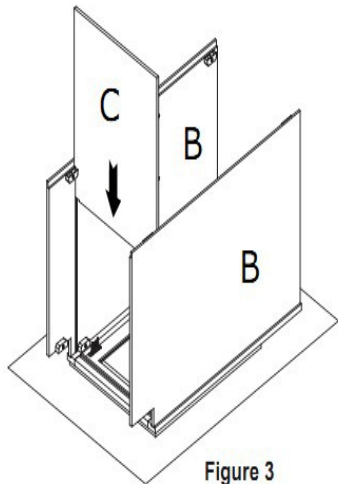

6. Installing the Corner Braces (Figure 6): Place the corner brackets(K) on each top corner of the cabinet and secure them with the 1/2" corner bracket screws. The 2" screws are used for connecting corner brackets and the counter top.

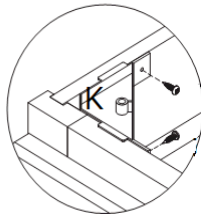
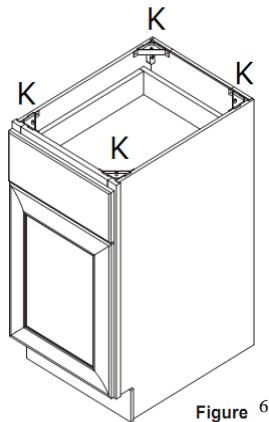

► Maintenance

For daily cleaning, use a dry cloth and a soft liquid cleaner.

Never use abrasive cleaners containing acetone, chlorine or strong bleach. Also, do not use tools as scrapers, metallic brushes, and other products which can scratch or tarnish surfaces.

Under no circumstances should you use chrome cleaner on chrome-plated or brass trim, hinges, handles, sockets etc.

Good ventilation is essential for maintaining the quality and look of this furniture.

► Limited 30 year warranty

This warranty applies to B. JORGSEN & CO. kitchen cabinets installed for residential use. B. JORGSEN & CO. warrants that, when installed in accordance with the installation instructions provided, the kitchen cabinets are free of manufacturing defects for a period of (30) thirty years from the date of purchase.

We guarantee your satisfaction with each kitchen cabinet. Should any kitchen cabinet not meet your satisfaction because of a visual defect, simply return it to your retailer, PRIOR to installation for a replacement. We are unable to correct any visual defects after installation is complete or after 5 days from the date of original delivery.

Information about your warranty coverage

This warranty does not cover damages or failure attributable to:

- Kitchen cabinets installed with obvious visual defects
- Defects or damage to kitchen cabinets caused by installation that does not comply strictly with the instructions provided with the kitchen cabinets.
- Issues related to the natural characteristics of wood products or the normal effects of aging
- Defects caused by product modifications completed by the owner/installer.
- Defects caused by exposure to the elements including moisture which may cause warping or splitting.
- Defects or damage to kitchen cabinets caused by severe accidents (e.g. fire, burns).
- Damage caused by flooding or standing water from leaking pipes, faucets, household appliances, etc: up to and including flooding and any damages caused by natural catastrophes.

Notes on Warranty:

- B. JORGSEN & CO. kitchen cabinets shall not be liable for either its failure to perform or its delays in performance hereunder arising out of or resulting from causes beyond its control, including but not limited to, acts of God, acts of Representatives, acts of Government, wars, fires, floods, epidemics, quarantine, strike, freight embargoes, weather or default by suppliers due to any such causes.
- This warranty applies only to the original purchaser and installation site and is not transferable.
- Wood characteristics naturally occurring such as variations in color, grain and knots are not considered defects.
- Color variations in cabinets are a natural occurrence due to wood species, age and exposure to UV light and sunlight and therefore such variations and changes are not considered defects.
- This warranty is valid only for residential installation

FOR WARRANTY SERVICE

To make a claim, contact CABINETS TO GO, acting as an agent for B. JORGSEN & CO., no later than 5 days following the date of receipt of product, at 1-800-CABINET option: 5. Proof of purchase, such as the bill of sale is mandatory when requesting warranty service.

Approved Returns are subject to a 25% restocking fee & must be approved prior to return, contact your local store for authorization.

- Product must be in original condition & properly stored. Installed product is considered accepted by the buyer & may not be returned or exchanged for any reason.
- CABINETS TO GO reserves the right to designate a representative to inspect the kitchen cabinet for analysis.
- No unauthorized person, installer, dealer, agent or employee of CABINETS TO GO or any other representative is entitled to assume any liability on behalf of CABINETS TO GO relating to the sale of this product or has the authority to increase or alter the obligations or limitations of this warranty.

THE SOLE REMEDY PROVIDED BY THIS WARRANTY IS THE REPAIR OR REPLACEMENT OF ANY PART OR PARTS THAT MAY PROVE DEFECTIVE UNDER NORMAL RESIDENTIAL USAGE. THIS WARRANTY DOES NOT COVER THE COST OF REMOVAL, INSTALLATION, DELAY OR TRANSPORTATION OF NEW PRODUCT.